





# INSTRUCCIONES DE MONTAJE

**A**  **M6\*60 12uds.**

**B**  **M6\*55 8uds.**

**C**  **3.5\*20 4uds.**

**D**  **3.5\*30 8uds.**

**E**  **3.0\*16 6uds.**

Panel frontal

Panel izquierdo

Panel derecho

Panel trasero

Remate Techo

Percha

Suelo

Techo

**Partes del ponadero**

Techo

Suelo

Divisor

Panel izquierdo

Panel trasero

Panel derecho

**PASO 1**

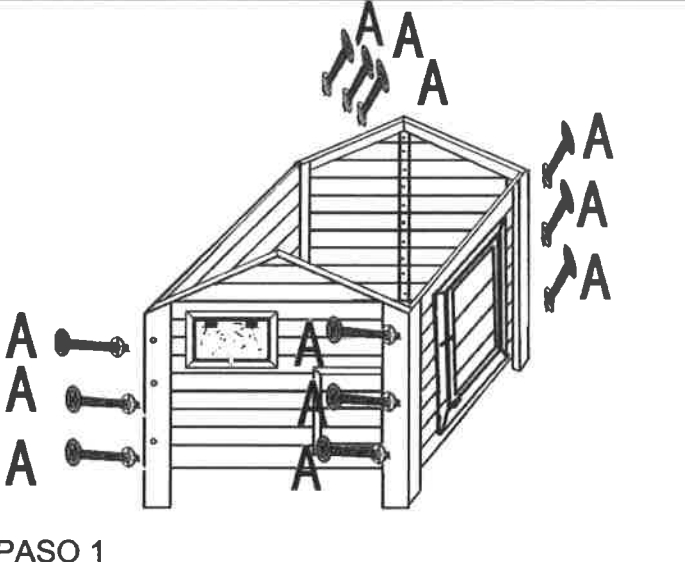

**PASO 2**

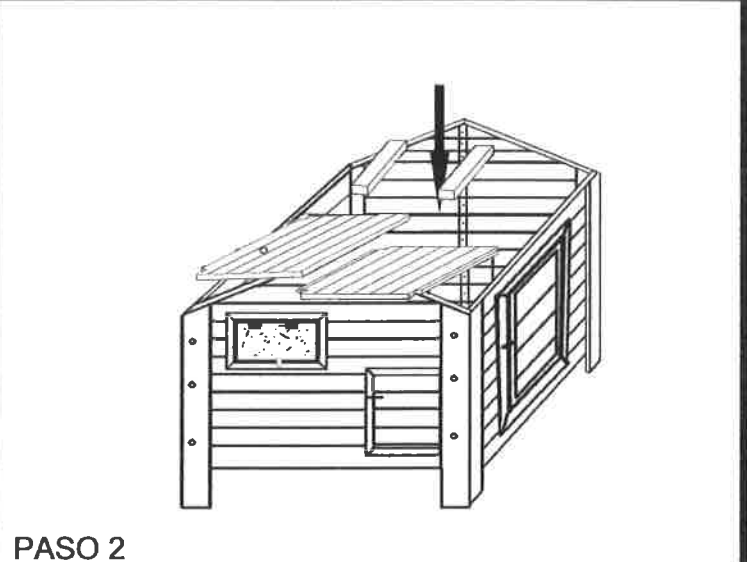

**PASO 3**

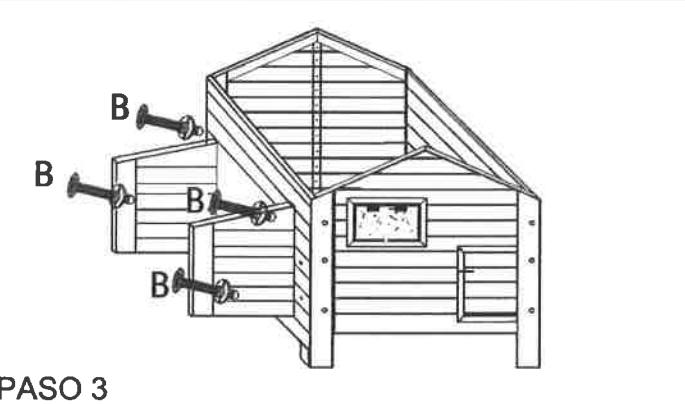

**PASO 4**

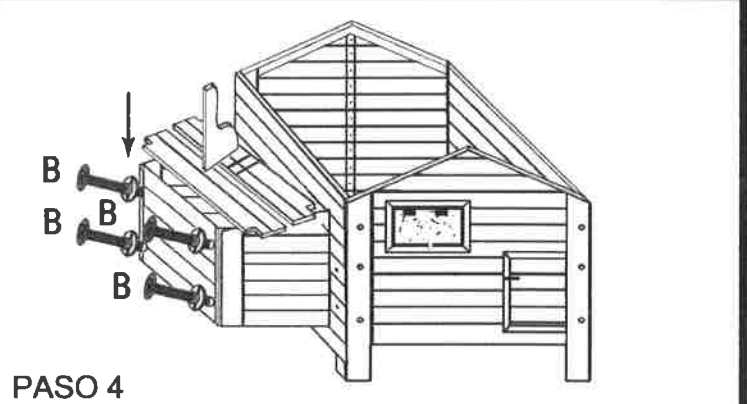

**PASO 5**

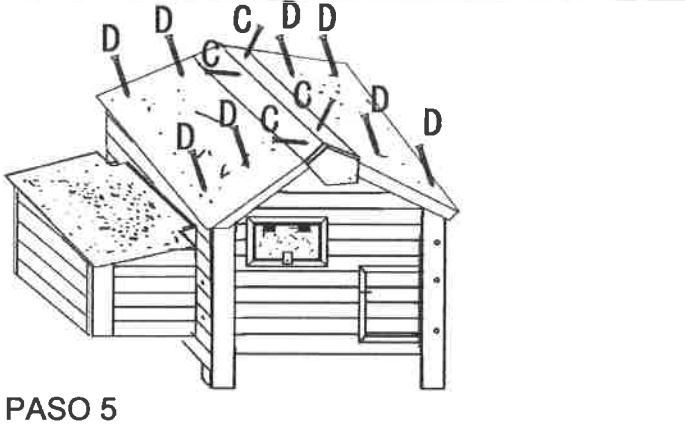

**PASO 6**

